



RESIDENTIAL ALUMINIUM WINDOWS AND DOORS COLLECTION

ALUK[®]
INSPIRING YOUR HOME



Stylish design to enhance your living space

Aluminium windows and doors that let the light flood into your home

AluK has quality and innovation at its heart, and our window and door systems improve the way we live our lives. Combining high performance design with elegant and innovative features, our glazing systems offer optimum comfort with maximum security.

For more than 20 years we've been developing windows and doors specifically for the UK market, answering the needs of homeowners and offering them reliable and low maintenance solutions that improve their living environment and add value to their home.

With stylish and attractive products to suit any property, our comprehensive range brings together innovative design, a wide range of finishes and the highest standards in security and performance to make your home comfortable, safe and secure.

"Windows and doors to complement the way you live your life"

The origin of windows

Prior to the Sixteenth Century, windows were predominantly found in the 'leaded light' style, which is still used for stained glass windows today. Combining small pieces of glass with lead framing, 'leaded light' windows were the result of the scarcity of glass and could only be afforded in the wealthiest homes. Chamfered stone mullions were already in use as were timber frames, but most buildings were unglazed and used shutters to protect their occupants from the elements.

Thanks to the relative stability of the Tudor dynasty, windows became bigger in the Sixteenth Century. Leaded lights continued, alongside stone and timber window frames, which benefited from a wider range of mouldings. However, most people still used shutters or oiled cloths, as glass was still very expensive.



Experimenting in style

The Nineteenth Century led to an explosion in creativity, as improved manufacturing methods and increased availability of materials meant a greater output of plate glass. Along with a variety of colours and patterns, glazed windows became common for shop fronts, which previously relied on shutters. Projecting windows, such as bay windows, became mainstream for houses in the late Nineteenth Century: the Gothic revival, which introduced wrought-iron window frames, the Arts and Crafts movement, which brought back leaded lights, and the Queen Anne style for sash windows.



16th Century

17th Century

19th Century

20th Century

The History of Windows

Over the past five hundred years, windows have undergone radical changes, thanks to the development of trends, materials and manufacturing. From cross casements to panoramic, here is a short history of windows.

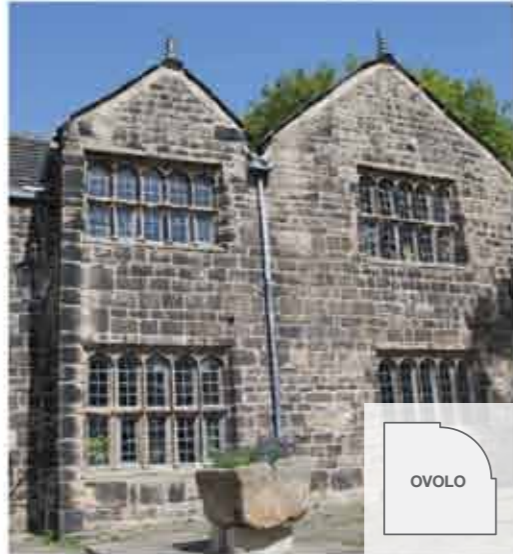

The growth of windows

The Seventeenth Century brought in a strong Renaissance influence to buildings, ushering in taller and narrower windows. Larger areas of glazing were now possible, with the size and position of windows indicating the importance of a building or the room within it. Cross casements, incorporating four larger panes of glass, became particularly widespread. Leaded light windows became uncommon as they struggled to hold the weight of larger panes of glass, while timber framing grew in usage. The range of frames also increased, as the Ovolo moulding became popular for stone mullions.

Sash windows became a fashionable fixture in the Eighteenth Century, as window frames continued to narrow and became thinner. In the 1770s, plate glass was introduced, which contributed to the decline of the cross casement window but enabled even larger windows to be produced.



Modern solutions

In the early Twentieth Century, windows also began to be produced in the modernist style for Art Deco buildings, incorporating new minimum profile steel frames.

Post-war construction of new housing saw an increase in available materials and many new house styles. With the developments made in the aircraft industry during the war, aluminium became a viable alternative for window construction, alongside popular painted softwood frames. In the 1970s and 80s many homeowners started to replace their timber windows as double glazing was introduced to improve warmth in their homes. Aluminium and uPVC became more popular, offering longer lasting and maintenance free solutions alongside a wider choice of frame styles, including aluminium frames with timber inserts that were cheaper than their hardwood timber alternatives.

As lifestyles and tastes changed the demand for narrow window profiles and large expanses of glass led to aluminium becoming very popular in modern building design. High performance glazing solutions have meant that homeowners can now open up large areas of their homes using sliding or bi-fold doors and with the inherent strength of aluminium, it is the perfect choice for modern living.

What to consider when choosing your window or door

We understand that installing new windows and doors is a significant investment and can be daunting. That is why we have listed below all the things that you should consider when choosing the right window and door for your home:

1. Material

All AluK windows and doors are built using one of the world's most sustainable building materials available: aluminium. Slim, lightweight and very strong, it adds that additional level of security to your home whilst also offering a low maintenance and long lasting solution. Also consider the lifespan of the windows and doors you are choosing. Aluminium is a sturdy and long lasting material that is 100% recyclable, and does not rust or decay over time, whereas other materials can rot or discolour.

2. Performance

Both acoustic and thermal performance are very important when making your decision. Every window system will offer different levels of both; however, there are standard ratings that offer you a guide to the thermal performance. All of our windows and doors offer the highest levels of thermal performance and exceed current building regulations, ensuring that your home is comfortable all year round and reduces your heating bills.



3. Security

Ensuring that your family is safe and secure in your home is a prime consideration when choosing the right windows or doors. Due to the inherent strength of aluminium, and the locking mechanism we supply with our windows and doors, they are all tested to PAS24 for enhanced security, and most are certified by the 'Secured by Design' scheme where applicable.

4. Condensation

This is a common problem that can be a result of our homes being warmer, combined with reduced ventilation due to factors such as loft insulation, carpeted floors, lowered ceiling heights and better draught exclusion, all of which are designed to keep your home warm but also reduce air flow. In the past un-insulated aluminium frames could also lead to condensation, however, this is overcome with today's modern frames through insulating thermal break technology.

Condensation is a ventilation problem but can be reduced through the installation of modern double glazed windows. These provide a heat barrier with an inner glazed surface that is warmer than the outer pane, thus reducing the formation of condensation. This can be enhanced through the addition of trickle vents, which allow you to improve ventilation when required.

5. Glazing Options

There is a wide range of glazing options to consider. The minimum requirement in the UK for new windows is double glazing but you can also choose triple glazing for higher thermal and acoustic performance; however, for most homes double glazing is sufficient.

Our windows and doors are also available in a complete range of glazing styles to complement the age and look of your home. Whether stained, patterned or leaded style glass or Georgian style bars, the choice is yours.

6. Handles and Fittings

There are many styles of handles and fittings available on the market. When choosing the right one for your windows and doors the look will be a major factor however you need to also consider durability and reliability. Handles are the most used part of a window or door and therefore have to stand the test of time. Our range of high quality handles and accessories ensure your windows and doors look great but are also strong.

7. Colour

When choosing the colour of your windows and doors don't just settle for white when you can have many different options from our standard range. The difference is that we apply a powder coated finish to our aluminium windows that is guaranteed for 25 years, with minimal maintenance



required compared to other materials. All of our finishes are covered by the Qualicoat standard.

8. Life Expectancy

Make sure you ask what guarantees are available on the windows and doors that you are considering. This will vary considerably between material type and manufacturer, however we offer a 10 year guarantee on our window and door systems and a 25 year guarantee (depending on location) on coatings, giving you peace of mind for many years to come.

9. Sustainability

The lifespan of aluminium windows can be up to 60 years and far exceeds that of timber or uPVC windows that may last up to 10 and 20 years respectively. In addition, aluminium is the sustainable alternative as it is 100% recyclable.

If you have any questions when choosing your perfect window or door, please contact your supplier or email AluK at info@alukhome.co.uk.

Why Aluminium Windows & Doors?

When looking for the perfect upgrade for your home, aluminium windows and doors are a great choice. Enhancing and complementing the look of your home, you can add a touch of style, whilst also protecting your family from both the environment and unwelcome visitors.

Aluminium windows and doors offer narrow profiles and slim sight lines that can make a real difference to the look of your property. Aluminium is lightweight, strong and regarded as one of the most sustainable building materials available, being almost 100% recyclable.

This inherent strength means that the security of your home is improved, there is no need to worry about warping or rust, and it is almost maintenance free.

You can also choose from a vast array of colours to suit your home, including a dual-colour option where the inside and outside colours can be different.

Performance Icon Key

Acoustics Air Wind

Water U-Value SBD

WER Green Guide

Energy Rating Green Guide

Please note that the performance indicators represent the optimal measurement rate. This may vary depending on the specifications of the windows and doors



Windows

TRADITIONAL	
Ovolo	12
Chamfered	14
Heritage	16
Bay Windows	18
MODERN	
Contemporary	20
Panoramic	22

Doors

Entrance Doors	26
Bi-Fold Doors	28
Premium Sliding Doors	32
Patio Doors	33



Windows

Keeping the elements out, letting the light in

AluK offers a complete range of window styles to complement your home, allowing you the choice of a reliable and attractive finish. Manufactured using aluminium, one of the world's most sustainable materials, our unique windows offer elegant and narrow sight lines alongside a full range of features, options and finishes.

Built to meet your needs, our stylish windows offer protection from the elements whilst opening up your home to a world of light. Wide expanses of glazing can be achieved to create a relaxed and comfortable living environment for you and your family to enjoy. And, with minimal maintenance and full guarantees, you can rest assured that you are installing the most reliable windows available.

"Innovative styles to complement your home"

OVOLO
Our Ovolo windows combine high performance design and a timeless profile to complement your home.

CHAMFERED
Traditional style meets modern performance with our Chamfered profile windows.

HERITAGE
Our Heritage windows are a perfect sustainable replacement for your period property.

BAY WINDOWS
Our Bay Windows offer a traditional look with clean lines to complement your home's design.

CONTEMPORARY
Our innovative contemporary window systems provide slim sight lines for a subtle, contemporary look.

PANORAMIC
Our Panoramic windows are perfect for modern homes looking for a floor to ceiling glazing option.

TRADITIONAL

MODERN

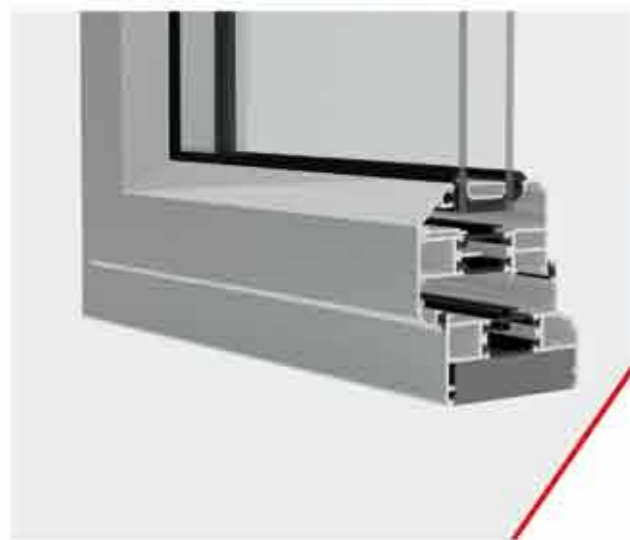

"Combining a timeless look with ground-breaking technology"

Classic solution:
our Ovolo windows are a classic, softline option

TRADITIONAL WINDOWS

Ovolo

Our traditional Ovolo windows combine a timeless look of sculpted framing with ground-breaking technology to provide your home with a classic, yet sustainable glazing solution.

Built to the highest UK standards, Ovolo is a high performance, robust and reliable window made of inherently strong aluminium, helping your home stay safe and secure.

With elegant profiles and customisable options, Ovolo is a classic style to complement the traditional look of your home.

- Perfect sculptured option for the frame and vent profiles
- Optional trickle ventilation
- Integrated night vent position
- Espagnolette multi-point locking
- Projecting top or side hung vents
- Child safety restrictions
- Double or triple glazing options
- Enhanced weather performance
- Tested to hurricane force winds
- Enhanced security and tested to PAS24
- Thermally broken profiles as standard with unique design to improve thermal performance

A 41dB Class 4 AE2400 600Pa 1.5 PAS24 B



"Classic design with added home safety and thermal performance"

Flexible and reliable:
the Chamfered window is ideal for a traditional look

A
 41dB
 Class 4
 AE2400
 600Pa
 1.5
 PAS24
 A

TRADITIONAL WINDOWS

Chamfered

Highly flexible and adaptable, our Chamfered range is ideal for homeowners looking for a traditional framing look.

Using innovative technology and sustainable aluminium, our chamfered windows improve safety, increase thermal performance and complement the style of your home.

The stylish but traditional Chamfered window comes with a variety of configurations and advanced functionality to meet your home's requirements, so you can rest assured that you have chosen the perfect solution.

- Classic chamfered option to add features and style to your windows
- Optional trickle ventilation
- Integrated night vent position
- Espagnolette multi-point locking
- Child safety restrictions
- Double or triple glazing options
- Enhanced weather performance
- Tested to hurricane force winds
- Enhanced security and tested to PAS24
- Surpasses the requirement of building regulations
- Thermally broken profiles as standard with unique design to improve thermal performance
- Can easily be combined with all AluK window and door systems



"A sustainable and high performance solution for period properties"

Heritage:
a smooth traditional-looking addition to your home

TRADITIONAL WINDOWS

Heritage

Our Heritage windows are perfect for period properties and offer an ideal replacement for steel-framed glazing.

Manufactured in the UK from lightweight aluminium, they offer a higher performance alternative to traditional windows, whilst still retaining the look and style of your property.

Designed to improve thermal & acoustic performance, this system is low maintenance and customisable, yet still replicates the narrow sight lines that traditional steel windows provide.

- Optional trickle ventilation
- Integrated night vent position
- Espagnolette multi-point locking
- Projecting top or side hung vents
- Child safety restrictions
- Enhanced weather performance
- Tested to hurricane force winds
- Enhanced security
- Surpasses the requirement of building regulations
- Green guide 'A' rating
- Standard hardware including concealed friction hinges and multi-point locking
- Thermally broken profiles as standard with unique design to improve thermal performance

A
 43dB
 Class 4
 AE2400
 600Pa
 1.5
 PAS24
 A

*"A complete range of solutions
for creating the timeless bay window"*

Bay Windows:
made possible by any of our
innovative window systems



TRADITIONAL WINDOWS

Bay Windows

All our window systems are ideal for the creation of Bay Windows, offering a solution with a classic profile and innovative design to suit your home.

Made from high performance aluminium, our Bay Window systems are a sustainable and reliable solution. Tested to PAS24, they provide the perfect solution for traditional and modern bay windows.

- Optional trickle ventilation
- Integrated night vent position
- Espagnolette multi-point locking
- Projecting top or side hung vents
- Double or triple glazing options
- Enhanced weather performance
- Surpasses the requirement of building regulations
- Thermally broken profiles as standard with unique design to improve thermal performance
- Can easily be combined with all ALUK window and door systems
- Multiple angles can be achieved

A
 41dB
 Class 4
 AE2400
 600Pa
 1.5
 PAS24
 B



"A modern look with minimal sight lines and high performance"

Opening your space:
the Contemporary window uses a clean and sleek design

A row of seven circular icons representing various performance metrics:

- A**: Green leaf icon representing Green Guide rating.
- 43dB**: Speaker icon representing sound reduction.
- Class 4**: Wave icon representing wind resistance.
- AE2400**: Flag icon representing air permeability.
- 600Pa**: Water drop icon representing water resistance.
- 1.5**: U-Value icon representing thermal insulation.
- PAS24**: SBD icon representing security.
- A**: WER icon representing weather resistance.

MODERN WINDOWS

Contemporary

For that stylish, modern look with clean lines and a sleek profile our Contemporary aluminium windows are the perfect choice.

Through innovative design and superior build quality, this window system offers high thermal and acoustic performance alongside the inherent strength and low maintenance benefits of aluminium to make your home safe and secure.

- Optional trickle ventilation
- Integrated night vent position
- Espagnolette multi-point locking
- Projecting top or side hung vents
- Child safety restrictions
- Enhanced weather performance
- Tested to hurricane force winds
- Enhanced security
- Surpasses the requirement of building regulations
- Green guide 'A' rating
- Standard hardware, including concealed friction hinges and multi-point locking
- Thermally broken profiles as standard with unique design to improve thermal performance
- Can easily be combined with all AluK window and door systems



"Minimal frame, maximum glazing for the ultimate view"

Panoramic:
the perfect choice for ambitious glazing designs



MODERN WINDOWS

Panoramic

For floor to ceiling glazing that offers unencumbered views from your home with minimal framing, our Panoramic window system is the perfect choice.

Opening up a room to let the light flood in, AluK Panoramic windows have narrow framing and can offer uninterrupted glazing to a height of 2 storeys. They are also tested to PAS24 and are built using strong but lightweight aluminium, combining aesthetics with improved security for your home.

Get the look with the ultimate in maximum glazing, minimum framing aluminium window systems and add a whole new perspective to your home.

- Can accommodate concealed opening vents
- 2-storey height glazing possible
- Integrated opening lights for ventilation
- Ultra-slim profiles, as narrow as 50mm
- Can incorporate skylight and sloped glazing with vertical glazing
- Range of contemporary external capping options
- Maximises natural light
- Double and triple glazing options
- Standard and high insulation options for tailored thermal performance
- Can easily be combined with all AluK window and door systems



ENTRANCE DOORS
Our entrance doors are available in a wide range of styles and are built to the highest levels of security and performance.



BI-FOLD DOORS
Bringing the outside in, our range of bi-folding doors allows you to open up your home to the outside whilst keeping the elements out.



PREMIUM SLIDING DOORS
A contemporary range of high performance, reliable sliding doors that offer superior levels of security.



PATIO DOORS
The perfect solution for opening your living space out into your garden or onto your patio.

Doors

Keeping the elements out, letting the light in

AluK offers a variety of aluminium door systems, each providing robust performance and expert design. Our doors are flexible, adaptable and come with a full range of features, options and finishes, allowing you to create the perfect doors to complement your home.

Sustainable and safe, our sleek doors offer protection from the elements whilst giving you the option of letting the outside in. Tested for enhanced security with several high performance locking features, they keep your home secure. And, with minimal maintenance, a complete range of colours and styles and full guarantees, you can rest assured that you are installing the most reliable doors available.

"Robust performance and expert design"



Secured by Design:
our entrance doors put your home's safety first

Family of Locks

AluK offers a complete family of highly secure multi-point locks to ensure the safety of your home. These robust and reliable systems include:

- **Auto-Mechanical Lock**
A lock with push-back hooks that automatically engage when the door closes without lifting the handle, providing instant security
- **Auto-Electrical Mechanical Lock**
Push-back hooks are engaged electrically for immediate locking, with the added option of electronic access controls, such as intercoms, for enhanced security



Entrance Doors

Our range of high performance Entrance Doors has safety and security at the heart of its manufacture, which is why all of our doors are tested to PAS24.

Available in single and double door configurations, our entrance doors offer a complete range of glazing formats and include several added security features, including multi-point locking mechanisms.

AluK entrance doors are available in a wide variety of colours, finishes and formats to best complement your home.

- Complete range of glazing, panel and hardware options available
- Available in single or double door configurations
- Accepts a full range of restrictors and access control devices
- Available as a standard door option or with PAS23 / PAS24 upgrade
- Multi-point locking mechanisms for enhanced security
- Cloaking feature conceals lock and prevents any access to locking points
- Single or dual colour options, polyester power coating and anodised finishes
- 'Secured by Design' certified
- Can easily be combined with all AluK window and door systems



Stunning living spaces

Imagine the difference bi-fold doors could make to your home and the way you use your outside space

Bi-fold Doors

Bi-fold doors are the ideal way to open up your home and bring the outside in, whilst still keeping the elements out.

AluK is a leader in the design and manufacture of aluminium sliding and folding doors, delivering outstanding reliability, performance and design every time. Our range of bi-fold doors enables you to expand your living space by opening up wide expanses of your external walls to your outside space, whilst at the same time keeping the weather out and the heat in during cold months.

Our stylish but practical bi-fold doors are built to your needs, offering you a bespoke solution every time, from the configuration of the doors to the handles, accessories and colour, making AluK bi-fold doors the perfect addition to your home.

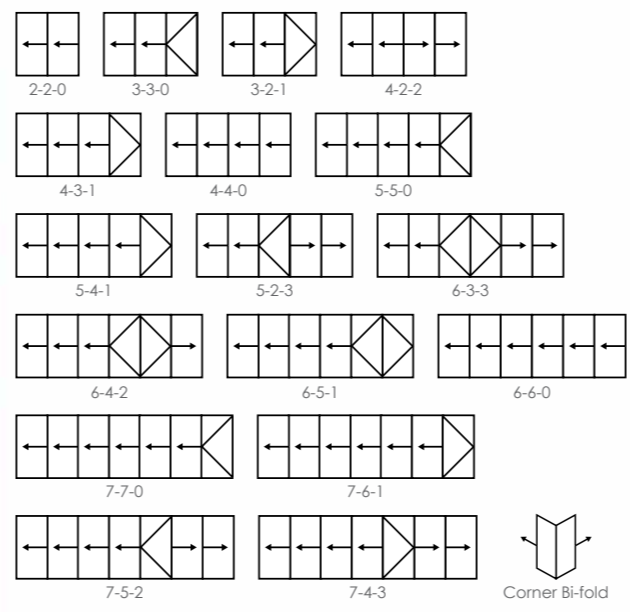



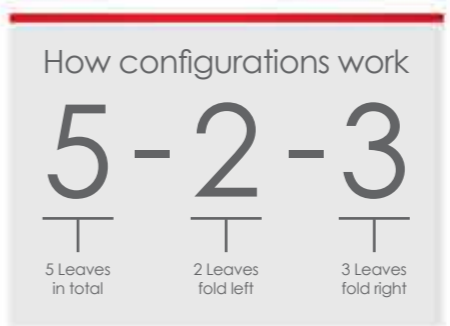

Configurations

The diagrams shown here illustrate some of the configurations achievable with AluK's bi-fold door system. Panels can be stacked inside or outside to meet your configuration and space needs.



"Get the design and performance you want with the style you deserve"

 **Class 4**
 **AE2400**
 **600Pa**
 **1.7**
 **PAS24**

Built for your home

Complete flexibility to suit your needs

Our bi-fold doors have been designed to provide you with the flexibility to create the perfect look that will complement your home and your lifestyle.

- Wide range of configuration options
- High performance glazing and design
- Minimal profiles for a modern look
- Complete range of handles and accessories
- Unique flush line pop-out handle option
- Full range of standard and bespoke colours
- Dual colour option for inside and out
- Chamfered and square bead options
- Tested to PAS24 for enhanced security and SBD
- Sturdy and reliable sliding mechanism
- Low threshold option for room dividers
- High performance as standard
- Can easily be combined with all AluK window and door systems
- Also available in a corner configuration



Premium Sliding Doors

Let the light into your home with high performance aluminium sliding doors

The AluK range of inline or lift and slide premium aluminium doors offers high performance complemented by stunning design, adding a modern and stylish look to your home, opening your living space to the outside.

Combining unique system design with a range of configurations, they will enhance your home whilst keeping the weather at bay.

- Narrow profile with single, double or triple track options
- Single or dual colour options in wide range of colours
- Complete range of handles, accessories and security features
- 3m high x over 3m wide panels
- Smooth operation through stainless steel rollers
- Lift and slide for large opening elements
- Floor to ceiling height sliding panels
- Can easily be combined with all AluK window and door systems

Configurations

- (A) One Panel Sliding
- (B) Two Panel Sliding
- (C) Three Panel, Single Sliding
- (D) Three Panel Sliding
- (E) Four Panel Sliding
- (F) Six Panel, Four Sliding

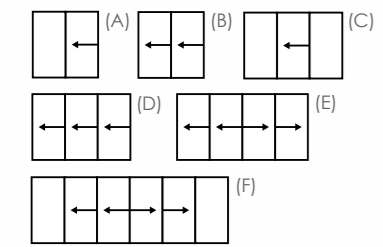

36dB Class 4 C3 E900 U-Value 1.7



Patio Doors

Minimal frame design to maximise glazing

Our range of patio doors offers an ideal and inexpensive solution for your home, with minimal frame design to let the maximum amount of light flood in.

Built to the highest standards, our patio door range combines flexibility with design and security to ensure your comfort and peace of mind.

- Narrowest frame design - only 70mm - ideal for replacement of old doors
- Two pane sliding door or window
- Full range of complementary handles and security features
- Robust and reliable sliding and locking mechanism
- Single or dual colour options in a wide range of colours
- Multi-point locking
- Can easily be combined with all AluK window and door systems

Configurations

- (A) Two pane sliding door
- (B) Two pane sliding window

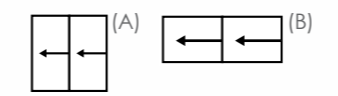

Class 2 C3 250Pa U-Value 1.7

"Let the light flood into your home whilst keeping the weather out"

The Aluk range of windows and doors is designed and manufactured to meet the specific needs of UK homeowners. Delivering high quality construction, demanded by stringent UK standards and regulations, as well as the performance required to protect your home from the elements, our stylish and robust windows and doors can be relied upon to always deliver.

Performance built-in

All our high performance window and door systems exceed current standards and regulations ensuring that our customers receive the best product every time. Through the design of unique technologies we ensure the highest thermal, acoustic and security performance.

Safe and secure

Combining high quality security features and hardware with the inherent properties of aluminium has allowed most of our windows and doors to be tested to PAS24 for enhanced security, and most are certified under the 'Secured by Design' scheme, where applicable. This ensures that our products provide the highest levels of security to our customers.



Design flexibility

With a wide range of profiles, frame depths, optional elements, finishes and hardware to choose from, you will always find an Aluk window or door to reflect your style and taste.

A splash of colour

Aluk windows and doors are available in a multitude of colours, from our standard range to the full RAL spectrum. Our profiles are polyester powder coated with the highest quality powders, providing you with the peace of mind of a 25 year guarantee. The choice is yours; pick from one of our standard finishes or choose a bespoke finish from more than 500 colours as well as a different colour inside and out.

Network of approved fabricators and installers

Aluk systems are fabricated and installed by an approved network of specialist glazing companies who have been trained by us to the highest standards. We pride ourselves on the high level of service our approved installer network can deliver, giving you a reliable and trustworthy service every time.

Peace of mind

We are proud of the quality and finish of our windows and doors, and to support this, we provide a 10 year system guarantee on our frames and hardware and a 25 year guarantee on coatings, subject to terms & conditions. Please contact us for full guarantee terms and conditions.

At Aluk customer service is paramount

We have a full customer service and technical team available to help you with your questions.

Whether you need technical advice on product choice and finish or just need to know more about the benefits of aluminium windows or doors, our experienced and knowledgeable team is on hand to help with your enquiry.



T: 01633 81 04 40
F: 01633 81 60 04
info@alukhome.co.uk
sales@alukhome.co.uk

 www.alukhome.co.uk

Registered Office: AlUK (GB) Limited Imperial Park Celtic Way Newport NP10 8BE
Registered Number: 02881320

